

Drive technology

Automatic format adjustment for your machine

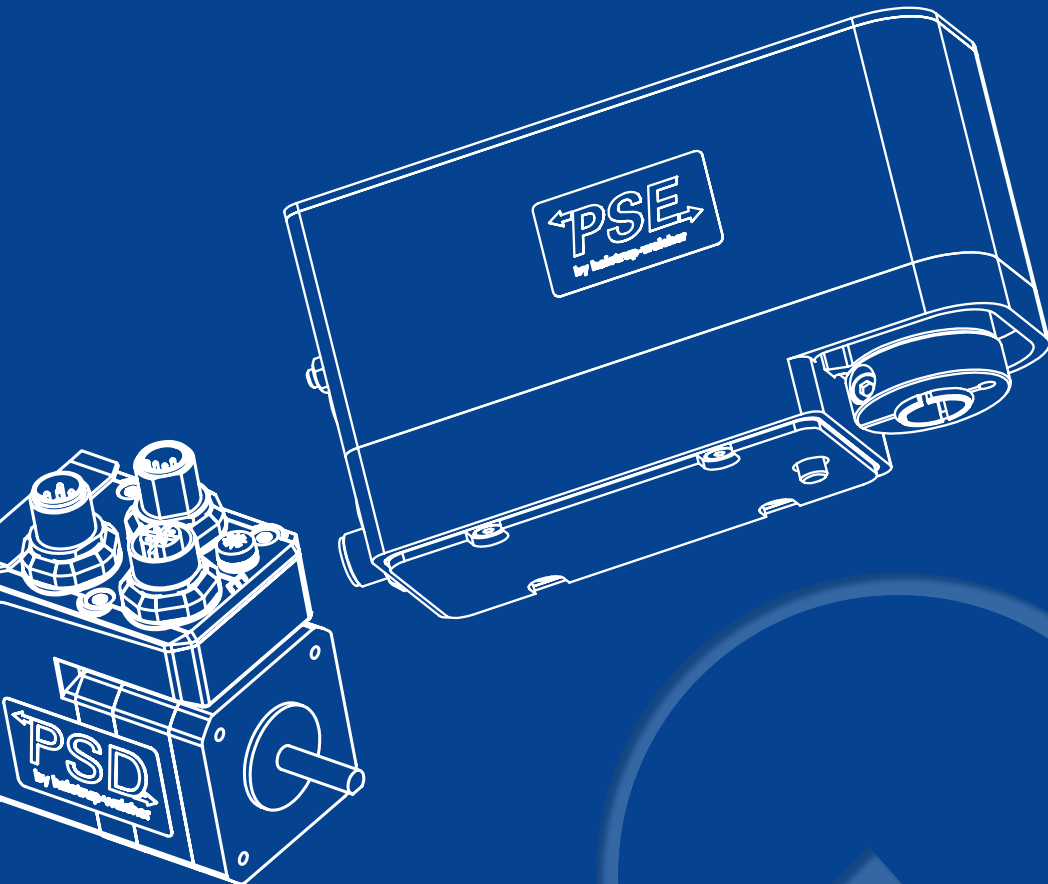

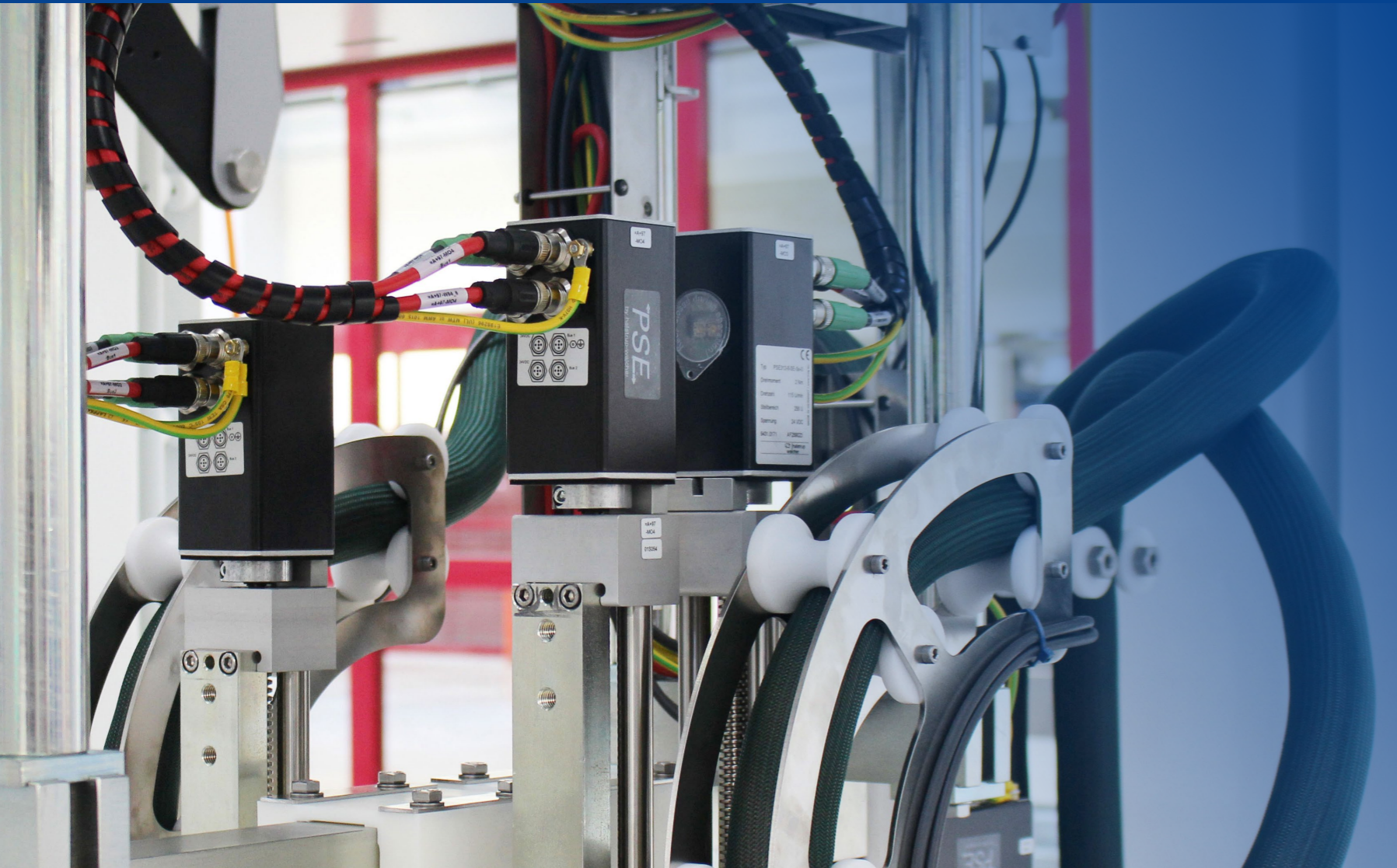



Increased efficiency through automatic format adjustment



Our expertise is in the automatic adjustment of machine and plant components by means of intelligent positioning systems.

We develop and supply customised, mechatronic drive technology for a wide range of applications. Thanks to our extensive modular product range, our positioning systems can be configured flexibly.

Your advantages when using automated format adjustment with halstrup-walcher solutions:

-  **Reduced set-up times**
-  **High repeatability / less waste**
-  **Efficiency even for small batch sizes / greater flexibility**
-  **Predictive maintenance with condition monitoring**

Positioning systems specifically for your field of application

We manufacture customized solutions for you in serial quality.

Let us find out together which positioning solution is the right one for your application. Our experts will advise you competently and find suitable products for your format adjustment needs, for example in packaging machines, bottling plants or woodworking machines. With our extensive modular system, you can configure your product individually. Through close exchange with long-standing customers, we are continuously developing our product families.

Customized products

If you request a product that we do not yet produce in series, we evaluate how quickly and to what extent we can offer you the required solution. To do this, we develop a requirement specification with the desi-

red features, which goes through a structured product development process in a close exchange between sales, development, prefabrication and final assembly. What makes us special: Mechanics and electronics are perfectly aligned with each other, as we have all competences under one roof thanks to our high level of vertical integration.

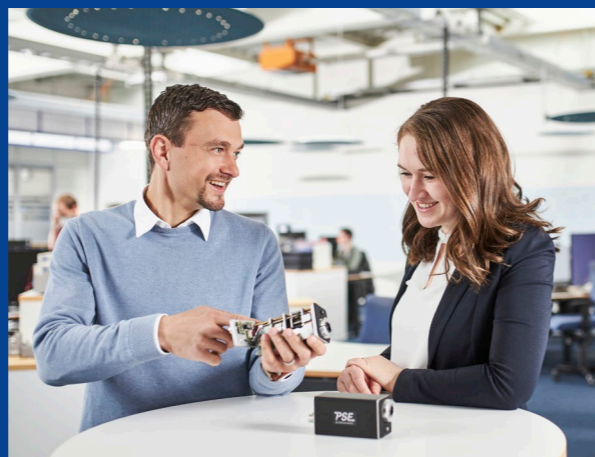

Packaging machines

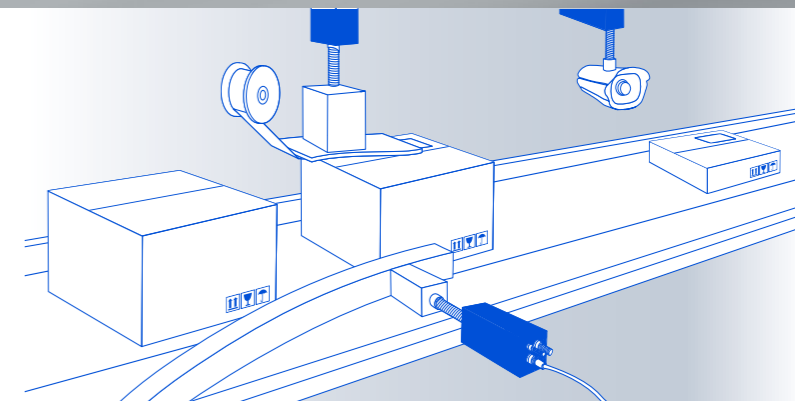

Bottling plants

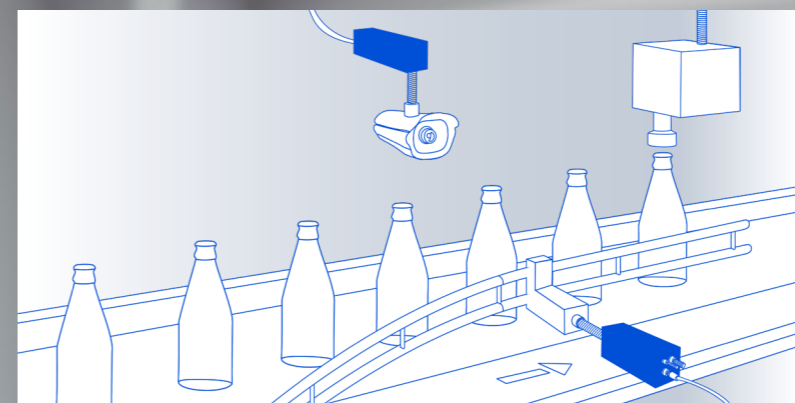

Woodworking machines

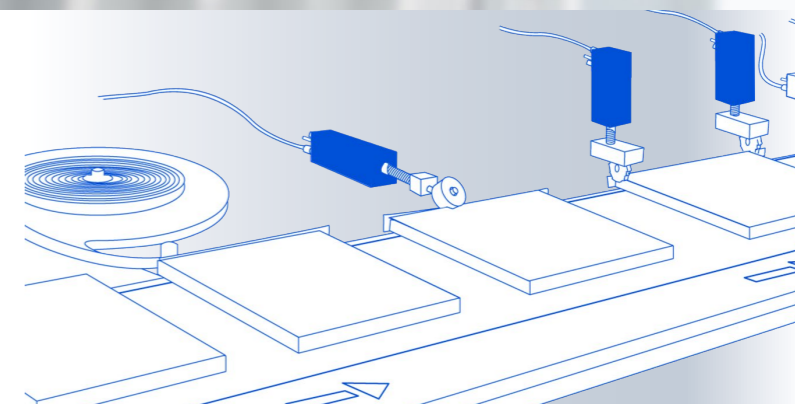

Possible performance ranges of our positioning systems



Nominal torque:
up to 50 Nm



Nominal speed:
up to 5000 1/min



Protection class:
up to IP69k



Bus communication:
PROFINET, EtherNet/IP, EtherCAT,
POWERLINK, IO-Link, PROFIBUS,
CANopen, Sercos, DeviceNet, Modbus



Certification:
STO
CE / UKCA, UL / NRTL, CCC, ...
Naval approvals

Positioning systems 3 series

The powerful and economical PSx3xx positioning systems with protection classes up to IP68 offer industrial automation solutions for the packaging, wood and beverage industries, for example.

In addition to the robust housing and strong performance, our 3 series family offers a range of software functions (e.g. drag error monitoring and regulation) that keep machine operation trouble-free and efficient. Due to the absolute encoder we developed without a buffer battery, no maintenance is required. With direct or indirect cabling and a flexible housing design, they adapt easily to your machine concept.

Furthermore, we offer simulation models (FMUs) for your digital machine twin.

Your advantages with our positioning systems of the 3 series:

1. Availability of safety function STO
2. Highest positioning accuracy
3. Safe operation due to galvanic separation of motor and control system
4. Easy to set up with Jog key operation
5. Matching brake available as an option
6. DurableEC motor



Targeted shutdown in case of overload

The PSE/PSS/PSW3xx is able to adjust the actual torque in such a way that the limit value, which can be parameterised by the customer, is not exceeded.

No jamming due to optimum synchronous operation

The positioning systems of the 3 series fulfil a synchronicity that prevents jamming. This is achieved by a very fast drag error control.

Direct drives 4 series

Our PSD drives are the compact and handy solution in IP50 and IP65 standard. Discover our direct drives in various dimensions and benefit from easy assembly and simple installation.

The PSD family stands out in particular for its compact format and offers a powerful direct drive despite its small size - ideal for machines that are looking for a space-saving solution for format adjustment without any loss of functionality. The PSD direct drives with stepper motor provide mechatronic systems with integrated control, bus interface and absolute measuring system without battery. They are ideally suited for adjusting machine axes during format adjustments.

Your advantages with our positioning systems of the 4 series are:

1. Compact construction
2. Highest flexibility in the configuration
3. Simple assembly
4. Large traverse range
5. 100% repeat accuracy
6. Powerful startup
7. Dynamic adjustment of axes
8. Safe operation due to galvanic separation of motor and control system

Modulo function enables infinite travel without limit

The modulo function in IO-Link devices offers you significant advantages when you want to constantly operate drives in the same direction of rotation, e.g. with turntables, tool changers or conveyor belts.



Process-oriented control of the speed in the process data

If your application requires frequent changes of the target speed, this can also be included in the process data for IO-Link devices. The undefined duration of an acyclic ISDU transmission is saved and the speed change is prioritised over acyclic commands.

used in more than **45** countries



halstrup-walcher GmbH
Stegener Straße 10
79199 Kirchzarten
Germany

www.halstrup-walcher.com
info@halstrup-walcher.de
T. +49 7661 3963-0

Contact us:



 | halstrup
walcher

Made in Germany